

Gasmate®

URBO GAS FIRE TABLE

Model No. GM142-163

- Stylish, powerful outdoor fire gives real presence to your deck or patio
- Powerful 52.8MJ/h stainless steel gas burner lit by electronic ignition
- Adjustable heat output
- Composite construction with contemporary concrete finish and marble table top and lid
- Glass beads provide ambient heat and a stunning flame effect
- 9kg LPG cylinder storage under unit
- Operates for approximately 8.5 hours on a properly filled 9kg LPG cylinder
- Complete with hose and regulator
- Assembled Dimensions (mm): 1220 W x 610 D x 600 H
- 2 year warranty
- Approved to NZ Standards

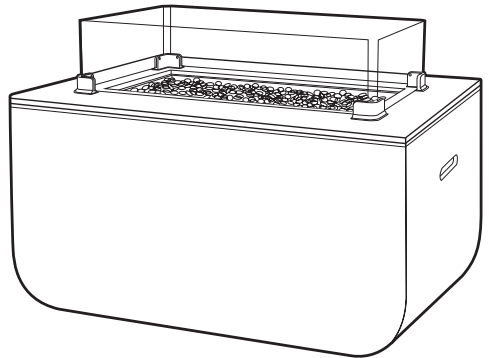

DANGER

If you smell gas:

1. Shut off the gas to the appliance.
2. Extinguish any open flame.
3. If odour continues, keep away from the appliance and immediately call your gas supplier or fire department.



WARNING:

Do not store or use gasoline, or other flammable vapors and liquids, in the vicinity of this or any other appliance.

An LPG Cylinder not connected for use shall not be stored in the vicinity of this or any other appliance.

Improper installation, adjustment, alteration, service or maintenance can cause injury or property damage. Read the installation, operating, and maintenance instructions thoroughly before installing or servicing this equipment.

CARBON MONOXIDE HAZARD



This appliance can produce carbon monoxide which has no odor. Using it in an enclosed space can kill you.

Never use this appliance in an enclosed space such as a camper, tent, car or home.



WARNING: For Outdoor Use Only

Important: Retain these instructions for future use.

INSTALLATION, OPERATION & MAINTENANCE INSTRUCTIONS



IMPORTANT SAFETY RULES

This appliance must only be used in a well ventilated area.

1. This appliance shall not be installed or used indoors, in buildings, garages or any other enclosed area.
2. **ALWAYS** place the appliance on a firm and level surface.
3. **DO NOT** place articles on or against this appliance.
4. **DO NOT** use or store flammable materials near this appliance.
5. **DO NOT** use in windy conditions.
6. **DO NOT** burn solid fuels in the appliance. 7. This is a decorative appliance only and any kind of cooking is strictly forbidden.
8. Children and adults should be alerted to the hazards of high surface temperatures, burns and clothing ignition.
9. Children should be carefully supervised when they are in the area of the appliance.
10. **NEVER** hang anything including clothes or other flammable items on the appliance.
11. **DO NOT** use this appliance if any part has been under water. Immediately call a qualified service technician to inspect the appliance and to replace any part of the control system and any gas control that has been under water.
12. **DO NOT** operate this appliance unless it is fully assembled.
13. **DO NOT SPRAY AEROSOLS IN THE VICINITY OF THIS APPLIANCE WHILE IT IS IN OPERATION.**
14. **Before use:** Remove any debris from within the grate area.
15. Installation and repair should be done by a qualified service person. The appliance must be inspected before use and at least annually by a qualified service person. More frequent cleaning may be required as necessary. It is imperative that control compartment, burners and circulating air passages of the appliance and light be kept clean.

Prior to assembling your appliance, the following must be reviewed. Compliance with the following should result in satisfactory appliance operation. This instruction manual should be retained for future reference. The installation must conform with local codes or authority having jurisdiction.

1. The appliance is intended for residential and nonresidential outdoor spaces. The installation must conform with New Zealand Standard 5601 "Gas Installations".

2. Adequate clearance around air openings into the combustion chamber, clearances from combustible materials, provisions for accessibility and for combustion and ventilating air supply must be maintained at all times when the appliance is operating.
3. Proper clearance from combustible materials must be maintained at all times. The minimum clearances are as follows::

Minimum Clearance from Combustibles

Side 1220mm

Rear 1220mm

DO NOT locate this appliance under any overhead enclosure. Avoid using near or under overhanging trees and shrubs. Combustible materials should never be within 3m of the top of the appliance.

Combustible materials are considered to be wood, compressed paper, plant fibres, plastic, plexiglas or other materials capable of being ignited and burned. Such materials shall be considered combustible even though flame proofed, fire-retardant treated or plastered. Additional clearance may be required for glass, painted surfaces and other materials which may be damaged by radiant or convection heat.

4. The appliance must be placed on a non-combustible level and adequate footing and be readily accessible.
5. The gas manifold supply pressure must be regulated at 2.75 kPa utilising an approved regulator (supplied with appliance).
6. The appliance must be inspected before each use, and at least annually by a qualified service person.
 - a. The appliance area must be kept clear and free of combustible materials, gasoline and other flammable vapours and liquids.
 - b. Gas orifices and burner must be kept clear of dirt and cobwebs. Flow of combustion and ventilation air through the perforated portions of the appliance must not be obstructed. Cleaning with a soft brush before use and at least every six months is recommended.
 - c. All gas connections should be checked for leaks utilising a soap solution. Never use a flame for this purpose.
 - d. The flame pattern at the emitter grid should be visually checked whenever the appliance is operated. If black soot is accumulating on the glass beads, the appliance should be turned off immediately. The appliance should not be operated again until the unit is serviced and or repaired.
 - e. Any cleaning agent used on the appliance should be of a non-combustible and non-corrosive nature. Warm soapy water is ideal. While washing the appliance, be sure to keep the area around the burner and pilot assembly dry at all times. If the gas control is exposed to water in any way, do NOT try to use it. The appliance should be regularly cleaned and protected to reduce oxidation, ideally a cover should be used when not in use.

7. The hose assembly should be properly located out of pathways where people may trip over it. The hose must be protected from contact with hot or sharp surfaces both during use and while in storage. The hose assembly should be visually inspected prior to each use of the appliance. If excessive abrasion or wear is evident, or the hose is cut, it must be replaced prior to operating the appliance. The replacement hose assembly may be obtained from the distributor.
8. **DO NOT** use any pressure regulator or hose assembly other than those supplied with the appliance. Replacement pressure regulator and hose assembly must be those specified. Replacement parts may be obtained from the distributor.
9. Installation and use of this appliance must conform with New Zealand Standard 5601 "Gas Installations".
10. This appliance is designed to operate with a standard 9Kg LPG cylinder to DOT 4BA-240 with Approved Cylinder Connection.
11. The valve outlet must be maintained in good condition. When the cylinder is not in use, be sure to cover it with a dust cap. A leak test should be performed with soapy water whenever connecting a new cylinder. **NEVER** use a flame to test for leaks.
12. The LPG cylinder must be turned off whenever the appliance is not in use. When the appliance is to be stored indoors, the LPG cylinder and the appliance must be disconnected and the cylinder stored in accordance with LPG Dangerous Goods Regulations.
13. Store the appliance upright in an area sheltered away from weather conditions. The use of a cover is recommended.
14. The appliance has been designed with several safety features which include a tip over switch and a flame safeguard system which means if the pilot goes out the unit will automatically turn off.

REGULATOR SAFETY FEATURE

All QCC regulators (the part that attaches to the gas cylinder to regulate the flow of gas) have a safety feature included that restricts gas flow in the event of a gas leak. You can inadvertently activate this safety feature without having a gas leak. This typically occurs when you turn on the gas using the appliance control knob before you turn on the gas cylinder valve. If the gas regulator safety feature activates, the appliance will operate with reduced output as gas flow is restricted.

These steps should be taken first to reset the gas regulator safety device:

1. Turn gas cylinder valve off.
2. Turn appliance off.
3. Disconnect the regulator from the gas cylinder.
4. Wait 30 seconds.
5. Reconnect the regulator to the gas cylinder.
6. Leak test the connection using a soapy water solution. Ensure no bubbles appear before proceeding.

7. Slowly open the gas cylinder valve all the way. Do not put excessive force on the valve at the full open position, to avoid damaging the valve.
8. Light the appliance as per the instructions provided. Any modification to the appliance not described in the installation instructions may compromise the safety of this appliance. Special concern is as follows:

- (1) **DO NOT** bypass thermocouple safety burner;
- (2) **DO NOT** operate appliance without the grate in place;

Clothing or other flammable materials should not be hung from the appliance, or placed on or near the appliance. The area above the burner may be extremely hot. Direct contact with these metal surfaces should be avoided in order to prevent burns or clothing ignition.

QCC CYLINDER CONNECTION DEVICE

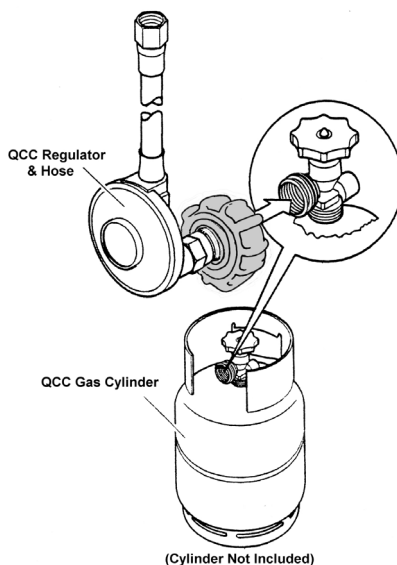

Screw the coupling nut of regulator into the cylinder valve outlet.

Type of Gas	I3/P28-30/ULPG
Consumption	52.8MJ/h
Operating Pressure	2.75kPa
Injector Size	1.95 mm

Heater specifications can be found on the data label.

GENERAL ASSEMBLY

Connecting & Disconnecting to Gas Source



IMPORTANT: Before connecting and disconnecting appliance to gas source, make sure control knob is in 'OFF' position.

CAUTION: When the appliance is not in use, the gas must be turned off at the cylinder.

Familiarise yourself with the general information and safety guidelines located at the front of this manual.

Check:

1. The cylinder is filled. A sloshing sound will be heard when shaken.
2. The control knob is in the 'OFF' position.

Connecting

1. Ensure cylinder valve is in its full off position.
2. Check for any damage to either the cylinder connection or the hose. NEVER attempt to use damaged equipment.

3. When connecting the hose to the cylinder tighten the nut to a positive stop by hand.
4. Open cylinder valve fully. If a leak can be heard at either end of the hose, turn cylinder off and tighten joint. Wait 5 minutes before re-testing and use a soapy water solution to check the joint. If bubbles appear the connection will need to be re-tightened. Refer to page 6 for more detailed instructions on connecting the appliance to the cylinder.

Disconnecting

1. Ensure the burner control is in the 'OFF' position.
2. Ensure cylinder valve is in the full off position.

For storage and cylinder exchange, disconnect hose at the cylinder only, DO NOT disconnect hose from appliance.

PARTS LIST

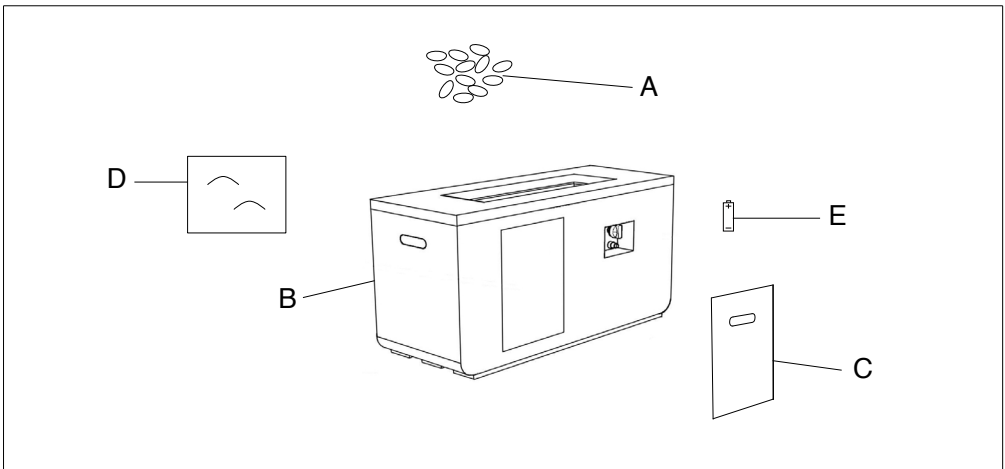



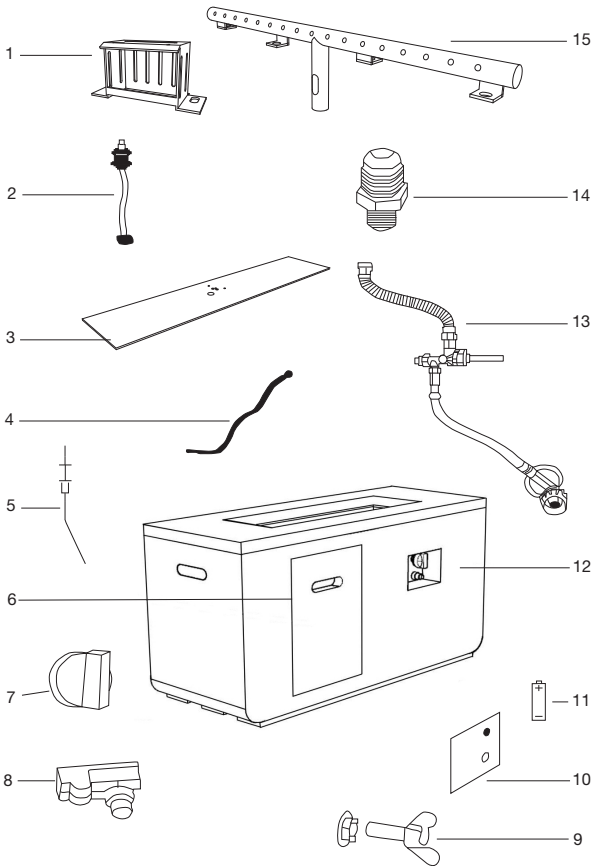

A	B	C	D	E
Glass Beads	Body	Door	Cover	Battery (AAA)
	1PC	1PC	1PC	1PC

GENERAL ASSEMBLY

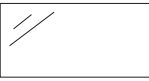

No.	Part Name	Qty
1	Screen	1
2	Thermocouple	1
3	Fire pan	1
4	Grounding wire	1
5	Ignition Pin/wire	1
6	Door	1
7	Control knob	1
8	Igniter	1
9	Wing screw	1
10	Control panel	1
11	Battery	1
12	Fire Table	1
13	Hose and regulator	1
14	Nozzle	1
15	Burner	1

GLASS SURROUND PARTS LIST

 <p>A. Glass Panel</p> <p>4PCS</p>	 <p>B. Bracket</p> <p>4PCS</p>	 <p>C. Screw</p> <p>8PCS</p>	 <p>D. L shaped silicon pad 65 x 65mm</p> <p>4PCS</p>	 <p>E. Square silicon pad 20 x 20mm</p> <p>8PCS</p>
---	---	---	--	---

ASSEMBLY INSTRUCTIONS

Your fire table must be installed on flat, stable surface, away from any combustible materials or construction.

Make sure the appliance control knob is turned “off” before assembling.

Note: Remove any transit protection material.

Tools required:

- Philips head screwdriver (or cordless drill and bits).
- Flat head screwdriver.
- Adjustable spanner.

STEP 1

Inside of the LPG compartment the gas hose and regulator assembly are already connected to the gas inlet of the appliance.

Place LPG cylinder in the LPG compartment.

Make sure the LPG cylinder base sits inside the metal stand easily and completely.

Turn the wing screw on the outer part of the metal stand clockwise to secure the LPG cylinder tightly.

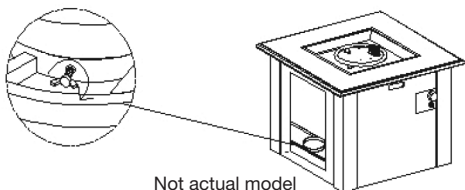

STEP 2

Ensure cylinder valve is in its full off position. Check for any damage to either the cylinder connection or the hose. NEVER attempt to use damaged equipment. Attach the regulator and hose to your gas cylinder. Tighten the nut to a positive stop by hand.

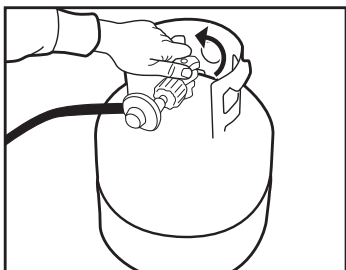

STEP 3

Turn on the gas cylinder ensuring that the control knob on the outdoor heater is turned OFF at this point. DO NOT ATTEMPT TO LIGHT THE HEATER.

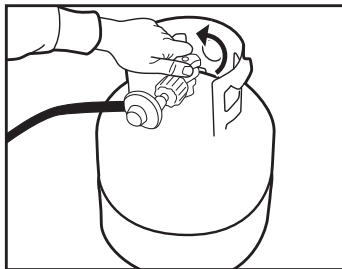

STEP 4

Use a solution of soapy water (dishwashing liquid and water is fine). Brush it on or use a spray bottle as shown in the drawing. Ensure the connections have a good coating.

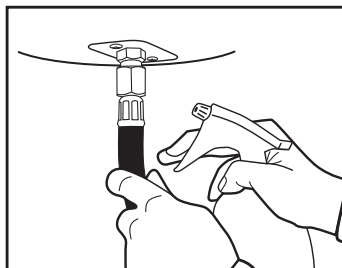

STEP 5a

If the connection is leaking, bubbles will start to grow in the soapy solution. If this happens shut off the gas supply at the cylinder.

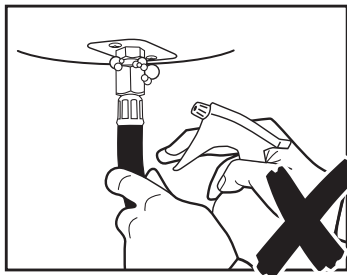

ASSEMBLY INSTRUCTIONS

STEP 5b

Tighten the connections using a crescent then repeat steps 3-4.

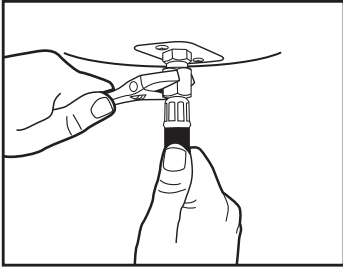

STEP 5b

The connection is gas tight when no bubbles grow around the gas connection.

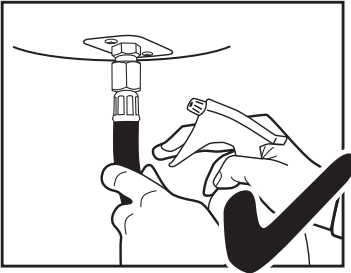

STEP 6

The ignition system works by battery. Unscrew the electronic igniter button and insert the AAA battery included. Make sure the positive pole (+) is towards the outside. Re-screw the button back to the battery case tightly.

STEP 7

Place all glass beads evenly in the fire table on the top of the appliance. Never cover the ignition screen when placing the glass beads into the fire table. Always keep ignition screen visible.

Note: Images are examples only. Burner shape may differ from the images below.



Correct



Incorrect



WARNING: This screen must be clear and free of obstructions at all times to ensure proper operation.

Screen

DO NOT place glass beads on the screen. Keep screen clear.



STEP 8 - Glass Assembly:

1. Locate brackets and the screw and silicon pad bag.
2. Place an L silicon pad (D) at the bottom of each bracket (B) and then arrange the brackets on the fire table top surrounding the burner. This will protect the table top finish.
3. Remove the glass panels (A) from the packaging. Place a square shaped silicon pad (E) on each side and corner of the glass. Insert the glass panel into the bracket. Tighten the screw (C) to secure the glass to the bracket. Be careful when tightening the screws not to damage the glass. Complete this on all four corners.
4. Ensure that the glass is centred on the table top.

TEST FIRING APPLIANCE

Test fire appliance, following the lighting instructions found on the appliance. Leak test all gas connections with soapy water. Soap bubbles indicate gas leakage. **DO NOT** use a flame to test for gas leaks.



WARNING: White smoke may appear around the burner during the first minute of the initial firing.

TEST FIRING APPLIANCE



IMPORTANT: Cover must be removed when burner is in operation.

For first time use and after every change of LPG cylinder the gas system must be purged of air before lighting. To do this, turn your LPG cylinder valve on and push in and turn the control knob to 'HIGH' position. Hold in control knob for 1 minute before attempting to light appliance.

1. Make sure that the control knob is in the 'OFF' position.
2. Remove LPG compartment panel to gain access to LPG cylinder. Turn cylinder valve to 'ON' position and replace panel.
3. Push in the control knob and keep depressed while turning to the ignition point marked with a '⚡' or 'LOW'. Once the control knob is at this point push the ignition button. The Igniter will spark automatically, if it does not spark, release control knob and return to the 'OFF' position. Then check if battery is inserted correctly or if the ignition wire has come loose under the burner.
4. When the burner is lit and flames are visible in the 'LOW' position release ignition button but keep the control knob depressed for a further 20 seconds and then release it.
5. If the burner does not stay lit, turn off control knob and the cylinder valve and wait 5 minutes and repeat from Step 1.
6. Burner is now lit in the 'LOW' position.
7. Adjust the flame and heat output by turning the control knob from 'LOW' to 'HIGH' a few times to check the flame stability.
8. Adjust control knob to desired output between 'LOW' and 'HIGH'.

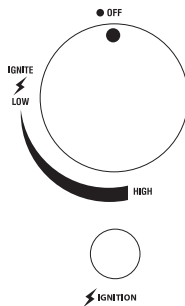

9. In the event that the flame goes out (due to wind or other reasons) the flame failure device will automatically shut off the gas supply after 60 seconds. To re-light start lighting process from Step 1.
10. To turn 'OFF' the appliance turn control knob to the 'OFF' position.
11. Open LPG compartment panel and turn the LPG cylinder valve to 'OFF' position.
12. Allow the appliance to cool before moving and covering for storage (at least 30 minutes).

Note: If for some reason, igniter fails to produce a spark at the electrode, fire bowl can be lit by a long match. Move glass beads to gain access to the burner (DO NOT touch unless completely cool). Wearing heat resistant gloves, position long lit match close to burner port. DO NOT lean over burner while lighting.

Push and turn burner control knob to "LOW" position. The burner should light within 5 seconds.

STORAGE & MAINTENANCE

To obtain the best performance from your fire table, you must perform the following storage and maintenance activities on a regular basis:

- Allow at least 30 minutes for the fire table to cool down after use, then disconnect and remove the cylinder.
- Store the gas cylinder in a dry, well ventilated and sheltered area away from weather and dust, out of the reach of children, and not in a building, garage or any other enclosed area.
- Storage indoors is permissible only if the cylinder is disconnected and removed. It is recommended that the fire table be stored indoors during the winter if it will be subjected to freezing temperatures.
- Keep the fire table area clear and free from combustible materials, gasoline and other flammable vapors and liquids.
- If the fire table is not in use, it must be covered to protect from weather or other adverse elements.
- Never use a vacuum cleaner on the glass beads.
- Installation and repair should be done by a qualified service person.
- The fire table should be inspected at least annually by a qualified service person. It is imperative that control compartment, burners and circulating air passageways of the fire table be kept clean.

TROUBLE SHOOTING

Problem:	Condition:	Solution suggested:
Appliance won't light	Igniter pin and burner are wet.	Wipe dry with a cloth.
	Igniter battery is incorrectly inserted.	Check that battery is correctly inserted.
	Igniter pin cracked or broken.	Contact retailer where purchased for replacement part.
	Electrode wire is loose or disconnected.	Reconnect wire to the igniter box located inside the table base behind the igniter button. 
Burner will not light using a match	No gas flow.	Check if gas cylinder is empty. If yes, replace.
	Regulator is not fully connected to the tank.	Check gas cylinder connection.
	Gas flow is obstructed.	Check hose for bends or kinks.
	Spider webs or insect nest in the venturi (end of burner tube).	Clean the venturi.
	Burner ports are clogged.	Insert an opened paper clip into each of the burner ports to clean them. Ensure the appliance is off and all parts are cooled before attempting to clean the burner ports.
Appliance emits a lot of black smoke when lit	Flame is obstructed at burner ports.	Make sure all the gas burner ports are free of any glass beads or debris to allow the gas to flow freely.
	Regulator hose is pinched.	Check the regulator hose for bends or kinks.
Sudden drop in gas flow	No gas flow.	Check if gas cylinder is empty. If yes, replace.
	Excess flow safety valve has been activated.	Turn the control knob to "OFF". Close the gas cylinder valve and disconnect the regulator from the cylinder. Turn the control knob to "HIGH". Wait 1 minute. Turn the control knob to "OFF". Reconnect regulator to gas cylinder. Open cylinder valve slowly. Light appliance as indicated in "To Light" section.
Flame blow out	High or gusting winds.	Increase flame to "High".
	No gas flow.	Check if gas cylinder is empty. If yes, replace.
	Excess flow safety valve has been activated.	See "Sudden drop in gas flow" above.
Irregular flame pattern or flame does not come out of the entire length of the burner	Burner ports are clogged.	See "Burner will not light using a match" above.

Note: If the appliance cannot be adjusted to perform correctly it should not be used until serviced or repaired.



WARNING: Improper installation, adjustment, alteration, service or maintenance can cause injury or property damage. Any modifications or adjustments made to product without prior authority from the manufacturer will void any warranty claims. Read the installation, operating and maintenance instructions thoroughly before installing or servicing this equipment.

This page has been intentionally left blank

This page has been intentionally left blank

OUTDOOR HEATER RANGE

Aber Living warrants the purchaser of this product against defects in workmanship and material, for a period of up to 24 months from the date of purchase. The warranty is non-transferable and becomes void if used for commercial or rental purposes.

Warranty and purchase receipt of this product are to be retained as proof of purchase and must be presented if making a claim under the terms of the Aber Living Warranty. Repairs under warranty are free of charge, provided the product is delivered to our Service Department or Authorised Service Agent and freight charges both ways are paid by the owner. No liability will be accepted for any loss of damage in transit.

Note: In most cases the Burner Head, Hose and Regulator only will need to be returned.

Aber Living reserves the rights to replace or repair the product within the warranty period. Warranty does not apply to any defect, deterioration (including corrosion if located within 1km of the sea), loss, injury or damage occasioned by or as a result of the misuse or abuse, negligent handling or if the product has not been installed and used in accordance with the instructions. The warranty is void if there is evidence of the product being tampered with by unauthorised persons.

If the product includes one or a number of accessories, only the defective accessory or part will be replaced, eg. hose, regulator, piezo igniter, or reflector.

In the event of Aber Living choosing to replace the product, the warranty will expire at the original date, i.e. 24 months from the original purchase date.

Where this product contains information from an overseas country, nothing in that information is intended to limit any condition, guarantee, right or remedy which may be available under the Consumer Guarantees Act 1993, except to the extent permitted by that Act.

Approved for Outdoor Use Only

For service, spare parts or product information in New Zealand, please call Aber Living on the Customer Service Line - 0800 161 161. www.aberliving.co.nz

YOUR PURCHASE RECORD (please complete)

Date of Purchase ____ / ____ / ____

Model Number _____

Serial Number (if applicable) _____

Purchased from _____

Attach copy of purchase receipt here