



SW-2201  
NEW ZEALAND SUPPLEMENTARY  
INSTRUCTION MANUAL

---

**Important: Retain these instructions for future use.**

---

## GENERAL INFORMATION



### IMPORTANT

Read these instructions carefully prior to use. Familiarise yourself with the appliance before connecting it to its gas container. Keep these instructions for future reference.



### IF YOU SMELL GAS

1. Shut off gas to the barbecue at its source, if possible.
2. Extinguish any open flame.
3. Open hood.
4. If odour continues immediately call your gas supplier or fire department.

### Gas Installation Codes

- Barbecues must be used in accordance with the installation requirements of your gas supply authority, or the New Zealand Standard 5601.
- Barbecues for use with bottled gas are labelled 'propane gas' or 'Universal L.P.G'.
- Barbecues for use with natural gas are labelled 'natural gas' and must be installed by an authorised person. Check the gas type sticker attached to the barbecue.

### Clearances

Minimum Clearances from combustible materials must be:

Rear - 300mm Sides - 300mm Above - 1000mm

### Specifications

Barbecue specifications can be found on the data label attached to the barbecue body.

Hose connection thread is 5/8"-18 UNF.

This appliance should be serviced annually by a qualified person.

### Hose & Regulator Safety

The regulator and hose assembly supplied with the barbecue are suitable for Propane Gas or Universal L.P.G. only.

A gas regulator adjusted to have an outlet pressure of 2.75kPa is supplied for connection to the propane gas cylinder. The pressure regulator and hose assembly supplied with the barbecue must be used. Replacement pressure regulators and hose assemblies must be those specified by the barbecue manufacturer.

When connecting the hose and regulator assembly to the gas cylinder, take care to avoid unnecessary twisting of the flexible hose.

After the assembly has been secured, turn on the gas and check for leaks by brushing a soap and water solution over all connections.

If you are unable to correct the leak by tightening the connections, turn off the gas and contact the supplier immediately.

Always ensure the barbecue is kept away from flammable materials and the gas cylinder clear of any heat source.

When changing over from an empty gas cylinder to a full one make sure this procedure is carried out in a well ventilated location, preferably outside, away from people and away from any sources of ignition; such as naked flames, pilot flames, electric heaters/equipment.

### Gas Cylinder Use & Safety

This is a low pressure barbecue and must only be used with the regulator supplied. Your barbecue is designed for use with 9Kg LPG cylinders.

The gas cylinder should be filled by a reputable gas supplier and visually inspected and re-qualified at each filling.

Always keep cylinder in an upright position. Always close the cylinder valve when the barbecue is not in use.

Do not subject gas cylinder to excessive heat.

### NEVER STORE YOUR GAS CYLINDER INDOORS.

If you store your barbecue indoors, ALWAYS disconnect the gas cylinder first and store the cylinder safely outside.

Cylinders must be stored outdoors in a well ventilated area out of reach of children, and must not be stored in a building, garage or any other enclosed area.

## GENERAL INFORMATION



### FOR YOUR SAFETY

Failure to comply with these instructions could result in a fire or explosion which could cause serious bodily injury, death or property damage.

#### **CAUTION: Accessible parts may be very hot.**

Keep young children away.

DO NOT modify this appliance.

DO NOT move this barbecue during use.

Turn off gas supply at the gas cylinder after use.

Parts sealed by the manufacturer or their agent must not be manipulated by the user. This barbecue is only to be used and stored outdoors.

- Never operate this barbecue without a regulator.
- Do not test for gas leaks with an open flame.
- If this information is not followed exactly a fire causing death or serious injury may occur. Do not store a spare gas cylinder under or near this barbecue. This barbecue is only to be used and stored outdoors.
- If there is a leak on your appliance (smell of gas) immediately attempt to turn off the cylinder valve. Remove the appliance to a well ventilated location away from any ignition source. Only check for leaks outdoors using soapy water. DO NOT try to detect leaks using a flame.
- Check for leaks by brushing a soap and water solution over all connections. If you are unable to correct the leak by tightening the connections, turn off the gas and contact customer service immediately.
- Only use the hose assembly as supplied with this appliance for connection to the cylinder - DO NOT USE ADAPTORS.
- Maximum hose length - 600mm.
- After use turn the gas cylinder valve off, wait for the flame to go out, then turn the appliance control valve off.
- Avoid twisting or kinking the flexible hose.
- Do not store or use petrol or other flammable liquids in the vicinity of this or any other appliance.
- Do not store empty or full spare gas cylinders under or near this or any other appliance.
- Never test for gas leaks with a lit match or open flame. Never light barbecue with hood closed or before checking to ensure the burner tubes are fully seated over gas valve orifices.
- Do not place articles on or against this appliance
- Do not spray aerosols in the vicinity of this appliance whilst it is in operation.

- Never lean over cooking surface when lighting.
- Never alter or modify the regulator or gas supply assembly.
- This barbecue must not be used indoors.
- Only use in well ventilated areas.
- CARBON MONOXIDE HAZARD - USING THIS APPLIANCE IN AN ENCLOSED SPACE MAY CAUSE DEATH. DO NOT USE IN CARAVANS, TENTS, MARINE CRAFT, CARS, MOBILE HOMES OR SIMILAR LOCATIONS.
- This appliance shall only be used in an above ground open-air situation with natural ventilation, without stagnant areas, where gas leakage and products of combustion are rapidly dispersed by wind and natural convection.
- Ensure the barbecue is set up on a level and stable surface.
- Do not move the barbecue while in use or when hot. Remove the drip tray before moving.
- DO NOT replace the grill with an extra hotplate. The warranty will be voided and it violates the gas approval, the grill provides the ventilation needed for the BBQ to operate safely. It is not designed to be a solid hotplate device.

#### **IF THERE IS A LEAK**

- Turn the cylinder off.
- Ventilate the area to disperse gas.
- Check all connections.
- If leak persists, keep the cylinder upright. Keep skin away from any gas or liquid escaping from the cylinder.
- Keep the cylinder at least 20 metres away from any sparks or ignition sources, including electrical equipment, camera flashes, engines and motors.
- Disperse gas by encouraging maximum ventilation and spraying with a fine water spray.

#### **IF THERE IS A FIRE**

- If the fire is at the barbecue, turn the gas off at the cylinder. Smother the flames with a wet cloth, fire blanket or extinguish using a fire extinguisher.
- If the fire is at the cylinder, or you can not get to the valve to turn the gas off, contact the fire brigade immediately.
- Using a garden hose, direct the water to the middle of the cylinder to keep it cool. Try not to extinguish the flame. At least if the gas is burning, it won't be able to build up pressure and explode.

## Location of your Barbecue

DO NOT use your barbecue in garages, porches, sheds, breezeways, or other enclosed areas. Your barbecue is to be used OUTDOORS. The barbecue is not intended to be installed in or on recreational vehicles and/or boats and should not be placed under any surface that will burn. Do not obstruct the flow of combustion and ventilation air around the barbecue housing.

## Protect Children

Keep children away from barbecue during use and until barbecue has cooled after you have finished. Do not allow children to operate barbecue.

Always ensure that no sporting or physical activities are carried out in close proximity to the barbecue during use and while still hot.

## Tools You Will Need

Adjustable spanner, Phillips head screwdriver.

## Check Barbecue for any Damage

Inspect barbecue parts as you proceed. Contact your supplier for assistance regarding replacement of any damaged or missing parts. Do not assemble or operate a barbecue that appears damaged. Barbecues for use with gas cylinders are labelled 'Propane Gas' or 'Universal L.P.G.'. Check labelling at the gas connection on your barbecue.

## Nominal Hourly Gas Consumption

	Main Burner
Gas Type	U.L.P.G
Inj. Size	0.90 mm
Gas Cons.	11 MJ/h
Gas Pressure	2.75 kPa

## GENERAL INFORMATION

### CONNECTING & DISCONNECTING TO GAS SOURCE

Familiarise yourself with the general information and safety guidelines located at the front of this manual.

#### Check

1. Gas cylinder is filled. A sloshing sound will be heard when shaken.
2. The burner control is in the 'OFF' position

#### Connecting

1. Ensure valve is in OFF position.
2. Check for any damage to the cylinder connection.
3. Attach the regulator to the cylinder valve.
4. Use a soapy water solution to check the joint. If bubbles appear the connection will need to be re-tightened.

### Overall Barbecue Dimensions

Length	Width	Height
940mm	450mm	400mm



#### IMPORTANT

- **IMPORTANT:** Before connecting and disconnecting barbecue to gas source, make sure burner controls are in 'OFF' position.
- **CAUTION:** When the barbecue is not in use, the gas cylinder must be disconnected.
- Check that the seals between the appliance and the gas cylinder are in place and in good condition before connecting the gas cylinder.
- Do not use this appliance if it has damaged or worn seals.
- **NOTE:** If for some reason, igniter fails to produce a spark at the electrode, barbecue can be lit by a long barbecue match with hood open insert the match into a hole on the underside of the barbecue and turn gas control to high.
- Check performance of burner prior to installing barbecue plates.
- Do not smoke when attempting to ignite barbecue.
- Never use volcanic rock, heat beads or other material.
- Always use protective gloves when handling hot components.

### LIGHTING PROCEDURE

#### Burner Operation & Ignition System Check

1. With cylinder valve in 'OFF' position check the igniter by pushing in the igniter button. Lift the flame tamer up and check for sparking to the burner.
2. If spark is not evident at the burner ignition point, check that the ignition lead is firmly attached to the control and sparker tip.
3. With sparking established push and turn the control knob anti-clockwise to '⚡' whilst simultaneously pushing the igniter button (Fig1).
4. If the burner fails to light after several attempts turn off gas and inspect for obstructions to gas flow.

If re-ignition is necessary while the gas barbecue is still hot, you must wait for a minimum of 5 minutes before commencing to re-ignite (this allows accumulated gas fumes to clear).

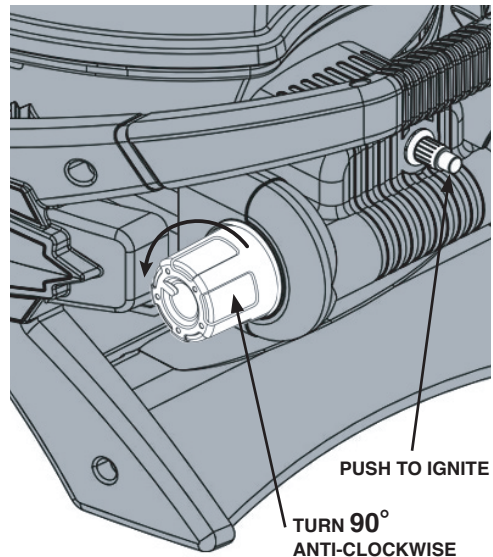
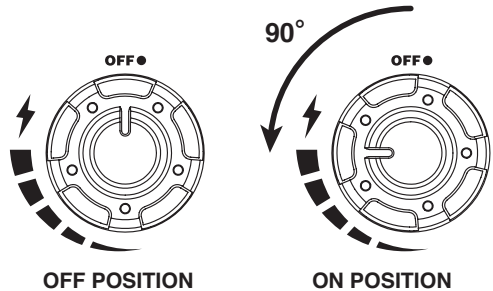

## OPERATION

### BURNER OPERATION & IGNITION SYSTEM CHECK

Problem	Possible Reason	Solution
Burner will not ignite	Control knob is closed	Turn knob to high when lighting
	Piezo igniter is faulty	Use a long barbecue match inserted through the hole on under side of barbecue
Food is not cooking or is taking too long	Burner has gone out	Check that the gas bottle is not empty and re-ignite the burner
	Cooking surface was not given enough time to warm up before the food was applied	Remove the food and give the burner time to warm the cooking surface (5-10 mins)
	There is too much food on the cooking surface	Cook smaller portions

### OPERATING PROCEDURE

#### Cooking

The control knob can be turned from 'HIGH' to 'MED' or 'LOW' depending on the heat required.

With the hood down the burner must only be used on 'LOW'.

#### Servicing

Servicing should be conducted every year or sooner if required.

The appliance must only be serviced by an authorised person.



#### IMPORTANT

The hood must be in the open position for lighting.

Do not smoke at any time when attempting to ignite the barbecue burners.

Do not leave the barbecue unattended when alight.

## CARE & MAINTENANCE

As with all appliances, proper care and maintenance will keep them in top operating condition and prolong their life. Your new gas barbecue is no exception. By following these cleaning procedures on a timely basis, your barbecue will be kept clean and working properly with minimum effort.

Spiders and small insects occasionally spin webs or make nests in the burner tubes during warehousing and transit.

These webs can lead to a gas flow obstruction which could result in a fire in and around the burner tubes. Cleaning with a soft brush before use and at least every six months is recommended.

This type of fire is known as 'FLASH-BACK' and can cause serious damage to your barbecue and create an unsafe operating condition for the user. Although an obstructed burner tube is not the only cause of 'FLASH-BACK' it is the most common cause and frequent inspection and cleaning of the burner tubes is necessary.

### Flash-Back

If fire occurs in and around the burner, immediately turn off gas at its source and turn the burner control to 'OFF', wait until the barbecue has cooled, then clean the burner tubes and burner ports.

### Cleaning the Cooking Surface

After cooking, turn burner control to 'OFF' and let barbecue cool before attempting to clean the grill plate or grate. Before first use and periodically, it is suggested that you wash the grill plate and grate in a mild soap and warm water solution.

### Care of Cooking Surface

Use and care of the cooking surface is important. Do not use pans on the cooking surface. Do not overheat the cooking surface with the hood down or no food on the cooking surface.

### Cleaning the Drip Tray

To avoid fat or grease dripping from the barbecue remove and empty the drip tray after each use. Wait until the drip tray is cool to touch before disposing of contents.

The drip tray should be washed periodically in a mild detergent and warm water solution.



### IMPORTANT

- Beware of spiders and wasps. Burner tube should be inspected and cleaned periodically.
- This appliance must only be serviced by an authorised person.
- To avoid any flare-ups, it is recommended that the drip tray be checked and emptied regularly. Contents of the drip tray may be very hot during cooking. If emptied during extended cooking extreme caution should be taken and direct contact by hand should be avoided at all times. Allow to cool completely before disposing of the contents.

## SAFE APPLIANCE LOCATIONS

This appliance shall only be used in an above ground open-air situation with natural ventilation, without stagnant areas, where gas leakage and products of combustion are rapidly dispersed by wind and natural convection.

**Any enclosure in which the appliance is used shall comply with the following:**

An enclosure with walls on all sides, but at least one permanent opening at ground level and no overhead cover.

Within a partial enclosure that includes an overhead cover and no more than two walls.

**Within a partial enclosure that includes an overhead cover and more than two walls, the following will apply:**

at least 25% of the total wall area is completely open, and

at least 30% of the remaining wall area is open and unrestricted.

**In the case of balconies, at least 20% of the total wall area shall be and remain open and unrestricted.**

### DIAGRAMMATIC REPRESENTATIONS OF OUTDOOR AREAS

The following figures are diagrammatic representations of outdoor areas. Rectangular areas have been used in these figures – the same principles apply to any other shaped area.

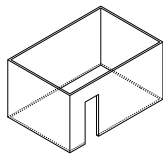

Outdoor Area - Example 1

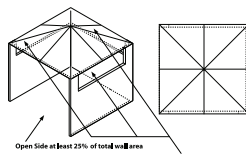

Open Side at least 25% of total wall area  
30% or more in total of the remaining wall area is open and unrestricted  
Outdoor Area - Example 4

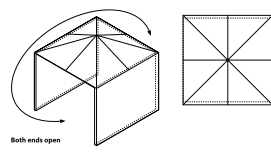

Both ends open

Outdoor Area - Example 3

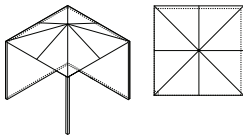

Outdoor Area - Example 2

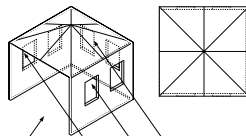

Open Side at least 25% of total wall area  
30% or more in total of the remaining wall area is open and unrestricted  
Outdoor Area - Example 5

Keep your purchase receipt, this will be required to make any claims under the 12 month warranty.

# Gasmate®