

Gasmate®

CAST IRON RING BURNERS

Model No. GM014-007, GM014-008, GM014-009

Ideal for camping

Suitable for cooking at home where larger pots and a higher heat output is required – Convenient for cooking sauces, crabs, lobster or any shell fish

Made from high quality cast iron with brass controls

Outlet: 5/8" American Standard

Hose and QCC Regulator included

LPG use only

Approved to NZ Standards



GM014-007

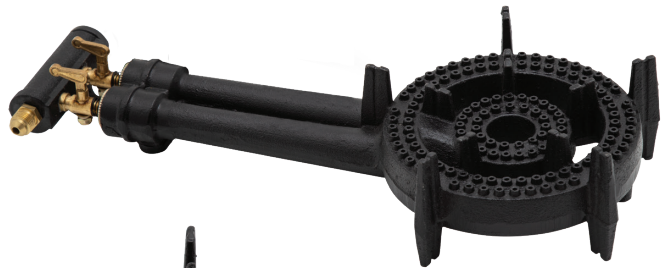

GM014-008

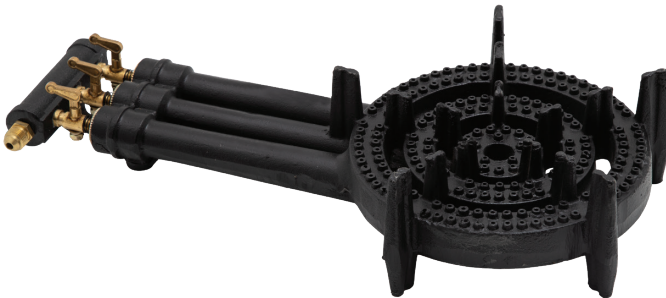

GM014-009



NOTE: ONLY USE ON A NON-COMBUSTIBLE SURFACE

Gasmate® is a registered trademark of: Sitro Group Australia Pty Ltd www.gasmate.com.au
Aber Living, N.Z. www.gasmate.co.nz

Important: Retain these instructions for future use.

GENERAL INFORMATION

Gas Installation Codes

- Appliance must be used in accordance with New Zealand Standard 5601 “Gas Installations”.
- Appliances for use with bottled gas are labelled ‘LPG/ULPG’.
- Only use on a non-combustible surface.

Clearances

Minimum Clearances from combustible materials must be: Cylinder - 500mm. Wall - 500mm. Above - 1200mm. Below - never use on a flammable surface. Only use on a non-combustible surface.

Hose & Regulator Safety

The regulator and hose assembly supplied with the appliance are suitable for LPG only.

The pressure regulator and hose assembly supplied with the appliance must be used. Replacement pressure regulators and hose assemblies must be those specified by the appliance manufacturer.

Only use the hose assembly supplied with this appliance for direct connection to the cylinder

“DO NOT USE ADAPTORS”.

Check the regulator “O” Ring periodically for wear or damage and replace if required.

When connecting the hose and regulator assembly to the gas cylinder, take care to avoid unnecessary twisting or kinking of the flexible hose. Maximum hose length is 1.2 metres.

After the assembly has been secured, turn on the gas and check for leaks by brushing a soap and water solution

overall connections.

DO NOT USE this appliance if it is leaking, damaged or does not operate properly.

If you are unable to correct the leak by tightening the connections, turn off the gas and contact the supplier immediately.

Always ensure the appliance is kept away from flammable materials and the gas cylinder clear of any heat source. When changing over from an empty gas cylinder to a full one make sure this procedure is carried out in a well ventilated location, preferably outside, away from people and away from any sources of ignition; such as naked flames, pilot flames, electric heaters/equipment.

Specifications

Appliance specifications can be found on the data label attached to the appliance body.

Gas Cylinder Use & Safety

This is a low pressure appliance and must only be used with the hose and regulator supplied. This appliance shall only be used with LPG from an LAB approved refillable cylinder. It may be hazardous to attempt to fit other types of gas containers.

The gas cylinder should be filled by a reputable gas supplier and visually inspected and re-qualified at each filling.

Always keep cylinder in an upright position. Always close the cylinder valve when the appliance is not in use.



IMPORTANT

- **Outdoor use only**
- **Read these instructions for use carefully. Familiarise yourself with the appliance before connecting it to its gas cylinder. Keep these instructions for future reference.**
- Failure to comply with these instructions could result in a fire or explosion which could cause serious bodily injury, death or property damage.
CAUTION: Accessible parts may be very hot.
- Keep young children away.
- DO NOT modify this appliance.
- DO NOT move this appliance during use.
- Turn off the gas supply at the gas cylinder after use.
- Parts sealed by the manufacturer or their agent must not be manipulated by the user
- This appliance is only to be used outdoors.

- Never operate this appliance without a regulator.
- Do not test for gas leaks with an open flame.
- If this information is not followed exactly a fire causing death or serious injury may occur.
- Do not store a spare gas cylinder under or near this appliance. Never fill the cylinder beyond 85% full. This appliance is only to be used and stored outdoors.
- If there is a leak on your appliance (smell of gas), immediately attempt to turn off the cylinder valve. Remove the appliance to a well ventilated location away from any ignition source. Only check for leaks outdoors using soapy water. DO NOT try to detect leaks using a flame.
- Never connect an unregulated gas cylinder to your appliance.

NOTE: ONLY USE ON A NON-COMBUSTIBLE SURFACE

Do not subject gas cylinder to excessive heat.

Never Store your Gas Cylinder Indoors.

If you store your appliance indoors, ALWAYS disconnect the gas cylinder first and store the cylinder safely outside. Cylinders must be stored outdoors in a well ventilated area out of reach of children, and must not be stored in a building, garage or any other enclosed area.

Gas connection is 5/8" American Standard

Location of your Appliance

Only use on a non-combustible surface. DO NOT use your appliance in garages, porches, sheds, breezeways, or other enclosed areas. Your appliance is to be used OUTDOORS ONLY. The appliance is not intended to be installed in or on recreational vehicles and/or boats and should not be placed on any surface that will burn. Do not obstruct the flow of combustion and ventilation air around the appliance.

Protect Children

Keep children away from appliance during use and until appliance has cooled after you have finished. Do not allow children to operate appliance.

Always ensure that no sporting or physical activities are carried out in close proximity to the appliance during use and while still hot.

Tools You Will Need

Adjustable spanner, phillips screwdriver.

Check Appliance for any Damage

Inspect appliance parts as you proceed. Contact your supplier for assistance regarding replacement of any damaged or missing parts. Do not assemble or operate a appliance that appears damaged. Appliance for use with gas cylinders are labelled 'LPG/ULPG. Check labelling at the gas connection on your appliance.

Product details:

GM014-007	One Ring Burner
Gas Type	LPG/ULPG
Gas Cons. (MJ/h)	9.1
Gas Pressure	2.75kPa
Overall size	305 x 170 x 78mm
Weight	2.8kg

GM014-008	Two Ring Burner
Gas Type	LPG/ULPG
Gas Cons. (MJ/h)	22.2
Gas Pressure	2.75kPa
Overall size	422 x 192 x 68mm
Weight	4kg

GM014-009	Three Ring Burner
Gas Type	LPG/ULPG
Gas Cons. (MJ/h)	33.8
Gas Pressure	2.75kPa
Overall size	466 x 246 x 88mm
Weight	7.2kg



FOR YOUR SAFETY

- Do not store or use petrol or other flammable liquids in the vicinity of this or any other appliance.
- Do not store empty or full spare gas cylinders under or near this or any other appliance.
- Keep the gas hose away from hot surfaces and protect from dripping grease. Avoid unnecessary twisting of hose. Visually inspect the hose prior to each use for cracks, excessive wear or other damage. Replace the hose if necessary.
- Never test for gas leaks with a lit match or open flame.
- Never lean over cooking surface when lighting.
- Never alter or modify the regulator or gas supply assembly.
- This appliance must not be used indoors.
- **ONLY USE IN WELL VENTILATED AREAS.**
- **CARBON MONOXIDE HAZARD - USING THIS APPLIANCE IN AN ENCLOSED SPACE MAY CAUSE DEATH. DO NOT USE IN CARAVANS, TENTS, MARINE CRAFT, CARS, MOBILE HOMES OR SIMILAR LOCATIONS.**
- This appliance shall only be used in an above ground open-air situation with natural ventilation, without stagnant areas, where gas leakage and products of combustion are rapidly dispersed by wind and natural convection.
- Ensure the appliance is set up on a level and stable surface.
- Do not move the appliance while in use or when hot.

NOTE: ONLY USE ON A NON-COMBUSTIBLE SURFACE

GENERAL ASSEMBLY

Connecting & Disconnecting to Gas Source

Familiarise yourself with the general information and safety guidelines located at the front of this manual.

Check:

1. Gas cylinder is filled. A sloshing sound will be heard when shaken.
2. The gas valve is in the 'OFF' position.

Connecting

1. Ensure cylinder and gas valve is in its full off position.
2. Check for any damage to either the cylinder connection or the hose. NEVER attempt to use damaged equipment.
3. When connecting the hose to the cylinder tighten the nut to a positive stop by hand or spanner.
4. Open cylinder valve fully. If a leak can be heard at either end of the hose turn cylinder off and tighten joint. Wait 5 minutes before re-testing and use a soapy water solution to check the joint. If bubbles appear the connection will need to be re-tightened.

Regulator Safety Feature

All QCC regulators (the part that attaches to the gas cylinder to regulate the flow of gas) have a safety feature included that restricts gas flow in the event of a gas leak. You can inadvertently activate this safety feature without having a gas leak. This typically occurs when you turn on the gas using the ring burner control knob before you turn on the gas cylinder valve. If the gas regulator safety feature activates, the ring burner will operate with reduced output as gas flow is restricted.

These steps should be taken first to reset the gas regulator safety device:

1. Turn gas cylinder valve off.
2. Turn off all control knobs.
3. Disconnect the regulator from the gas cylinder.
4. Wait 30 seconds.
5. Reconnect the regulator to the gas cylinder.
6. Leak test the connection using a soapy water solution. Ensure no bubbles appear before proceeding.
7. Slowly open the gas cylinder valve one turn. Do not put excessive force on the valve at the full open position, to avoid damaging the valve.
8. Light ring burner as per the instructions provided.

General Positioning

1. Never place or position the ring burner on combustible material. Only use on a non-combustible surface.
2. Ensure the gas hose is straight and not knotted.

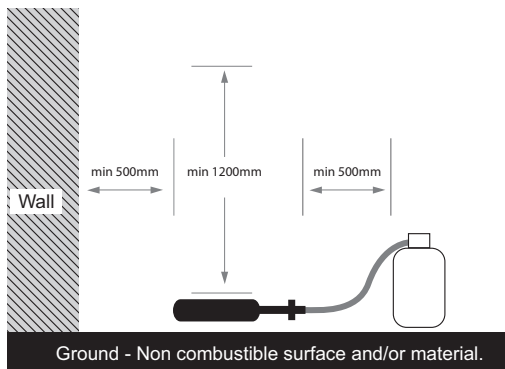

RING BURNER COMPONENTS (Image as guide only)

1. Hose and Regulator assembly
2. Gas valve screws from underside
3. Burner
 - GM014-007 - 1 ring
 - GM014-008 - 2 rings
 - GM014-009 - 3 rings
4. Trivets - to stand cooking pot on

Note: Remove any transit protection material before using the burner.

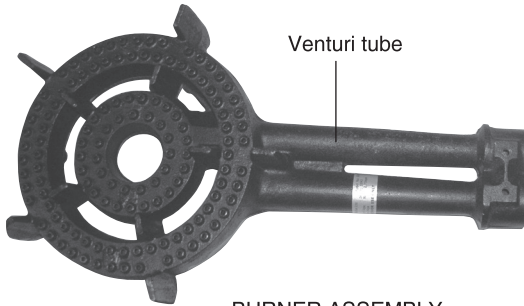
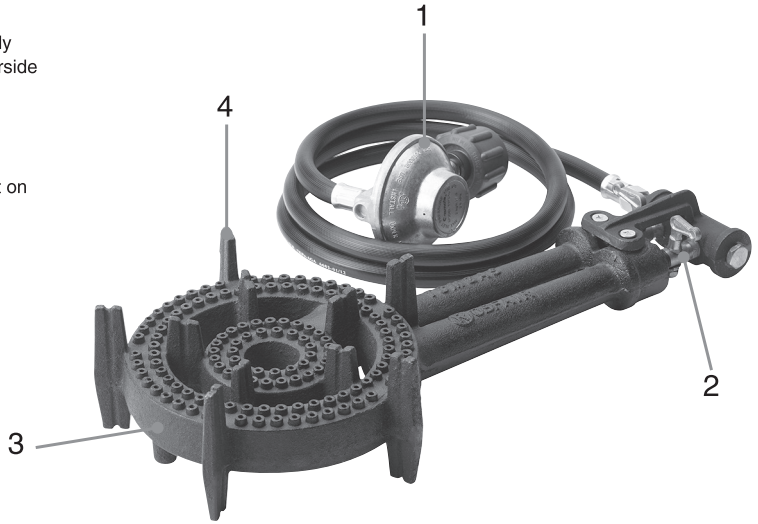

GAS VALVE ASSEMBLY

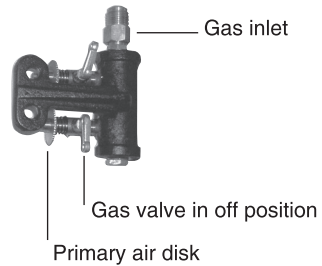

ASSEMBLY INSTRUCTIONS

Note: Remove any transit protection material before using the burner.

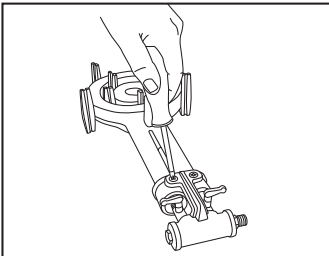

Step 1

Slide gas valve assembly into the burner assembly and secure with the two screws provided.

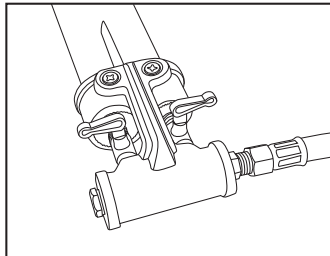

Step 2A

Attach the supplied hose and regulator to the gas inlet.

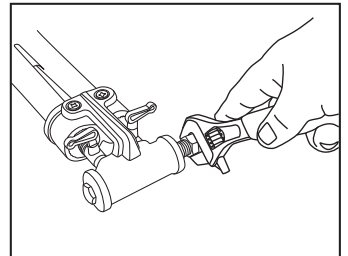

Step 2B

Using an adjustable crescent (spanner) tighten the nut by approximately $\frac{1}{4}$ of a full turn.

ASSEMBLY INSTRUCTIONS

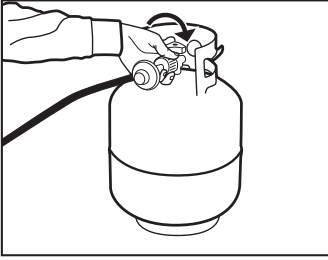

Step 3

Attach the regulator to your gas cylinder.

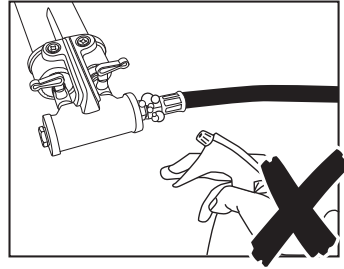

Step 6A

If the connection is leaking, bubbles will start to grow in the soapy solution. If this happens shut off the gas supply at the cylinder.

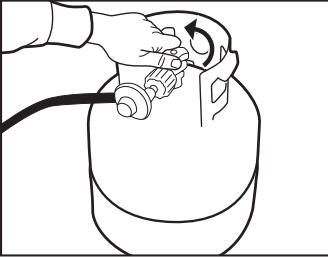

Step 4

Turn on the gas cylinder ensuring that all of the controls on the Country Cooker are turned OFF at this point. DO NOT ATTEMPT TO LIGHT THE RING BURNER!!

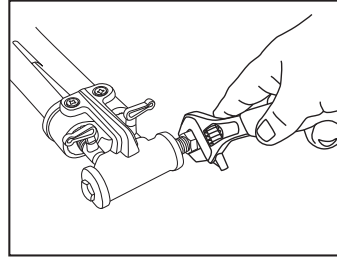

Step 6B

Retighten the connections using an adjustable crescent (spanner) then repeat steps 4-5.

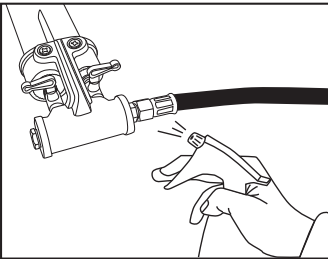

Step 5

Use a solution of soapy water (dish washing liquid and water is fine). Brush it on or use a spray bottle as shown in the drawing. Ensure the connections have a good coating.

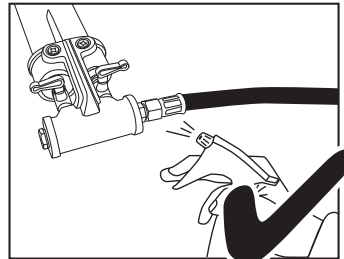

Step 6C

The connection is gas tight when no bubbles grow around the gas connection.

LIGHTING PROCEDURE

Burner Operation & Ignition System Check

1. Turn outer gas valve on and light immediately with long BBQ match.
2. Turn on all other gas valves, these rings will cross light.
3. Once lit adjust the primary air disk to provide a clean blue flame.
4. Place cooking pot onto ring burner.

OPERATING PROCEDURE

The gas valve can be adjusted from “OFF” to “HIGH” and this will affect the cooking time.

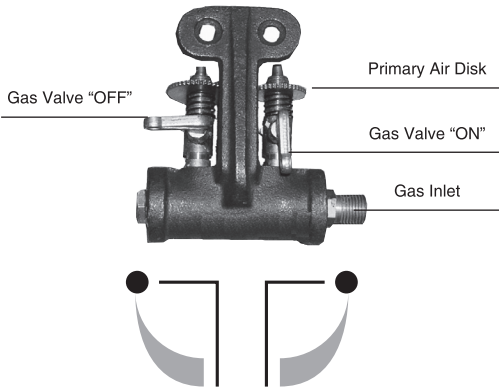

Gas valve “ON” max.

The gas lever is in a straight line with the gas valve to the venturi tube.

Gas valve “OFF”

The gas lever is at right angles to the gas valve and the venturi tube.

Spillage

Turn off the cylinder gas valve. Wait for the flame to go out. Using heat proof gloves:

- Remove cooking pan.
- Blow liquid from burner ports.
- Tip burner upside down to drain spilled liquid.
- Once dry re-position.
- Follow lighting procedures to re-light burner and continue cooking.

After Use

Turn the gas cylinder valve off and wait for the flame to go out. Then turn the appliance gas valve off.

! IMPORTANT

- Do not smoke when attempting to ignite appliance.
- Always use protective gloves when handling hot components.
- Do not smoke at any time when attempting to ignite the appliance burners.

Caution:

Do not move the appliance while in operation.

- Do not leave the appliance unattended when alight.

NOTE: ONLY USE ON A NON-COMBUSTIBLE SURFACE

Problem	Possible Reason	Solution
Burner will not ignite	Valve on gas bottle closed.	Open valve on gas bottle.
	Control knob is closed.	Turn knob to high when lighting.
Food is not cooking or is taking too long	Burner has gone out.	Check that the gas bottle is not empty and re-ignite burner.

AERATION

Check that the gas pressure is 2.75kPa. Adjust the primary air screw so that the flame burns clean and blue with no yellow or soot. Screwing the screw clockwise will decrease the air and tend to make the flame yellow. Screwing it anti-clockwise will make the flame more blue but may cause the flames to "lift" away from the burner.

Keep the Ring Burner clean and do not allow cooking residues or rust to block the burner ports. If some ports do not seem to be burning or the flames are "lifting" off the burner ports, take the Ring Burner to a qualified service person.

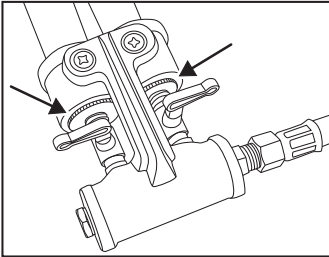

CARE & MAINTENANCE

As with all appliances, proper care and maintenance will keep them in top operating condition and prolong their life. Your new gas appliance is no exception. By following these cleaning procedures on a timely basis, your appliance will be kept clean and working properly with minimum effort.

Spiders and small insects occasionally spin webs or make nests in the burner tubes during warehousing and transit. These webs can lead to a gas flow obstruction which could result in a fire in and around the burner tubes. Cleaning with a soft brush before use and at least every six months is recommended.

This type of fire is known as 'FLASH-BACK' and can cause serious damage to your appliance and create an unsafe operating condition for the user. Although an obstructed burner tube is not the only cause of 'FLASH-BACK' it is the most common cause and frequent inspection and cleaning of the burner tubes is necessary.

Flash-Back

If fire occurs in and around the burner, immediately turn off gas at its source and turn the burner control to 'OFF', wait until the appliance has cooled, then clean the burner tubes and burner ports.

Cleaning

After cooking, turn burner gas cylinder valve and burner valve to 'OFF'. Let the burner cool before attempting to clean and store. After use brush excess dust, dirt and debris from the burner surface. Ensure all the burner ports are clean and open before storing and re-using. Ensure the bottoms of all cooking pots / pans are cleaned of any dirt or discolouration after use.

IMPORTANT

Before connecting and disconnecting appliance to gas source, make sure burner controls are in 'OFF' position.

CAUTION: When the appliance is not in use, the gas must be turned off at the cylinder.

Check that the seals between the appliance and the gas cylinder are in place and in good condition before connecting the gas cylinder.

Do not use this appliance if it has damaged or worn seals.

- Beware of spiders and wasps. Burner tube should be inspected and cleaned periodically.
- This appliance must only be serviced by an authorised person.

**NOTE: ONLY USE ON A
NON-COMBUSTIBLE SURFACE**

SAFE APPLIANCE LOCATIONS

This appliance shall only be used in an above ground open-air situation with natural ventilation, without stagnant areas, where gas leakage and products of combustion are rapidly dispersed by wind and natural convection.

Only use on a Non-combustible surface.

Any enclosure in which the appliance is used shall comply with the following:

An enclosure with walls on all sides, but at least one permanent opening at ground level and no overhead cover.

Within a partial enclosure that includes an overhead cover and no more than two walls.

Within a partial enclosure that includes an overhead cover and more than two walls, the following will apply:

at least 25% of the total wall area is completely open, and

at least 30% of the remaining wall area is open and unrestricted.

In the case of balconies, at least 20% of the total wall area shall be and remain open and unrestricted.

DIAGRAMMATICAL REPRESENTATIONS OF OUTDOOR AREAS

The following figures are diagrammatical representations of outdoor areas. Rectangular areas have been used in these figures – the same principles apply to any other shaped area.

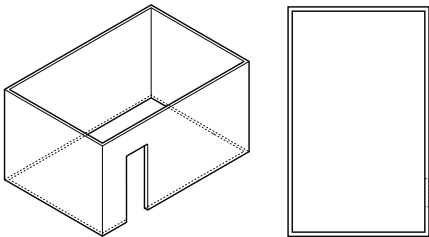

Outdoor Area - Example 1

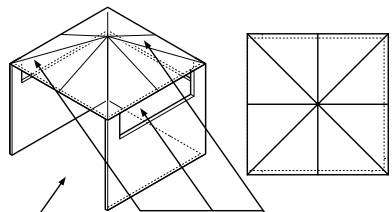

Open Side at least 25% of total wall area

30% or more in total of the remaining wall area is open and unrestricted

Outdoor Area - Example 4

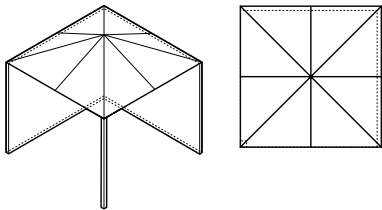

Outdoor Area - Example 2

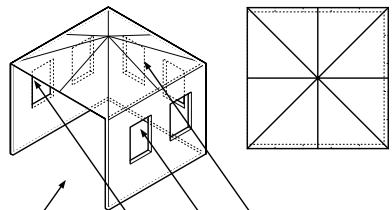

Open Side at least 25% of total wall area

30% or more in total of the remaining wall area is open and unrestricted

Outdoor Area - Example 5

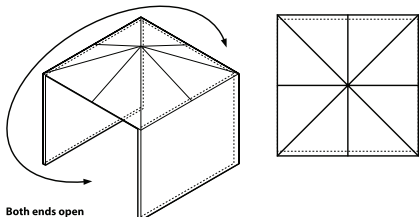

Both ends open

Outdoor Area - Example 3

WARRANTY

Aber Living warrants the purchaser of this product against defects in workmanship and material, for a period of up to 12 months from the date of purchase. The warranty is non-transferable and becomes void if used for commercial or rental purposes.

Warranty and purchase receipt of this product are to be retained as proof of purchase and must be presented if making a claim under the terms of the Aber Living Warranty. Repairs under warranty are free of charge, provided the product is delivered to our Service Department or Authorised Service Agent and freight charges both ways are paid by the owner. No liability will be accepted for any loss of damage in transit.

Aber Living reserves the rights to replace or repair the product within the warranty period. Warranty does not apply to any defect, deterioration (including corrosion if located within 1km of the sea), loss, injury or damage occasioned by or as a result of the misuse or abuse, negligent handling or if the product has not been installed and used in accordance with the instructions. The warranty is void if there is evidence of the product being tampered with by unauthorised persons.

In the event of Aber Living choosing to replace the product, the warranty will expire at the original date, i.e. 12 months from the original purchase date.

Where this product contains information from an overseas country, nothing in that information is intended to limit any condition, guarantee, right or remedy which may be available under the Consumer Guarantees Act 1993, except to the extent permitted by that Act.

Approved for Outdoor Use Only

For service, spare parts or product information in New Zealand, please call **Aber Living** on the Customer Service Line - **0800 161 161**.
www.aberliving.co.nz



YOUR PURCHASE RECORD (please complete)

Date of Purchase ____ / ____ / ____

Model Number _____

Serial Number (if applicable) _____

Purchased from _____

Attach a copy of your purchase receipt here.